

# LAXA DECO+

PENDANT/CEILING LIGHT

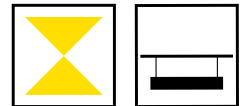

## KEY FEATURES

- Suspended and Rod Suspended versions
- Diameters from 300mm to 800mm
- Direct lighting in 2700K, 3000K or 4000K colour temperatures
- A range of dimming/control options including Fixed Output, 1-10V, DALI, Touch-Dim or Casambi control
- CRI >80 as standard, with >90 on request
- Integrated 3 hour emergency conversions available
- White, Silver, Graphite, Black, Champagne or Copper finishes with contrasting reflector finishes including Satin Gold
- Multisensors on request



**CASAMBI**

**60 YEARS  
IN LIGHT**

### FOR MORE INFORMATION OR TO TALK ABOUT A PROJECT:

CALL: +44 (0) 1235 55 37 69  
EMAIL: [sales@optelma.co.uk](mailto:sales@optelma.co.uk)

ISSUE DATE: 04/01/21

**HEAD OFFICE**  
The Science Park  
Abingdon  
Oxfordshire  
OX14 3YT

**SHOWROOM**  
23 Bowling Green Lane  
Clerkenwell  
London  
EC1R 0BD

**PARIS OFFICE**  
28 Rue Charles  
Baudelaire  
75012 Paris  
France

**SWISS OFFICE**  
St. Urbangasse 53  
Postfach 1738  
CH-4502 Solothurn  
Switzerland

**LAXA DECO+ DIRECT-INDIRECT SPECIFICATIONS**

PRODUCT OPTIONS	
Dimensions (mm):	Suspended: 58 (H) x Various Diameters (below)
Cut-out (mm):	N/A
Weight (kg):	-
Lifetime:	50,000 hrs
Mounting type:	Suspended Central*, Suspended Rod
Finish (Body):	White, Silver, Graphite, Black, Champagne, Copper
Finish (Reflector ring):	White, Silver, Graphite, Black, Champagne, Copper, Gold
Emergency:	Standard 3 hour emergency conversion
Operating voltage:	230V
IP Rating:	IP40
Light source:	Medium Power LED, High Power LED
Driver:	Fixed Output (Switched), DALI, 1-10V, Touch-Dim, Casambi
Colour temperature:	2200K, 2700K, 3000K, 3500K, 4000K, 6500K
Beam Angle:	N/A
Diffuser:	Opal, MPO
CRI:	CRI 80+, CRI 90+
Optional Extras:	Multisensor, Radar sensor, Cable colour: Black / Red

\* Suspended central minimum suspension height is diameter -100mm (200-700mm).  
Direct 55%, Indirect 45% distribution.

**CHOOSE A PROJECT SPECIFIC SOLUTION FROM THE FOLLOWING LUMINAIRE SIZES**

SUSPENDED Diameter (mm)	Medium Power Dir/Ind. MPO	High Power Dir/Ind. MPO	Medium Power Dir/Ind. Opal	High Power Dir/Ind. Opal
300	1710lm / 14W	2930lm / 25W	1690lm / 14W	2900lm / 25W
400	3360lm / 26W	5130lm / 41W	3360lm / 26W	5130lm / 41W
500	4810lm / 37W	7720lm / 61W	4830lm / 37W	7780lm / 61W
600	6230lm / 45W	9020lm / 68W	6330lm / 45W	9130lm / 68W
800	11300lm / 86W	13790lm/110W	11460lm / 86W	13990lm/110W

\* Luminaire luminous flux with 4000K LED. Direct-Indirect suspended only.

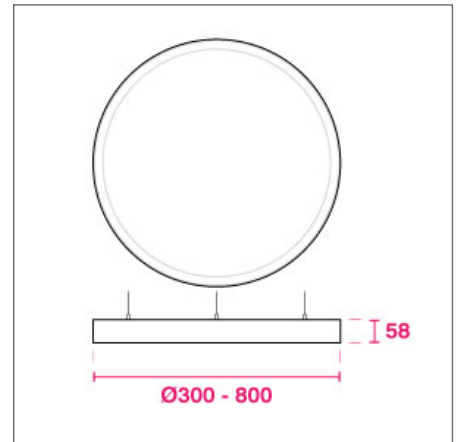

CROSS-SECTION DIMENSIONS (MM)

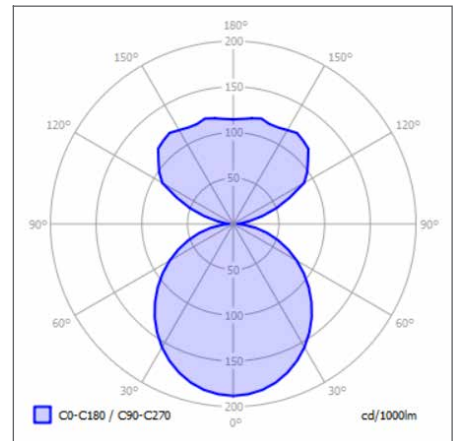

POLAR CURVE 4000K OPAL

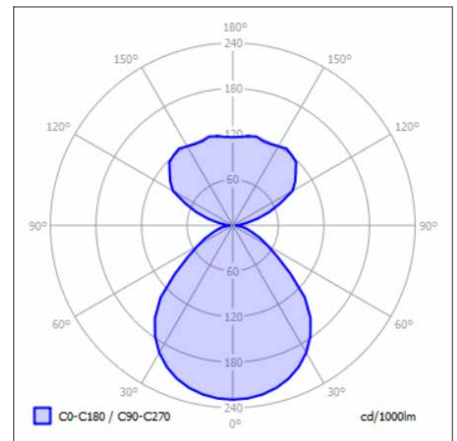

POLAR CURVE 4000K MPO



**FOR MORE INFORMATION OR TO TALK ABOUT A PROJECT:**

CALL: +44 (0) 1235 55 37 69  
EMAIL: sales@optelma.co.uk  
ISSUE DATE: 04/01/21







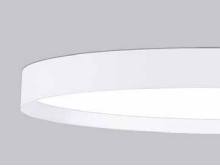

**HEAD OFFICE**  
The Science Park  
Abingdon  
Oxfordshire  
OX14 3YT

**SHOWROOM**  
23 Bowling Green Lane  
Clerkenwell  
London  
EC1R 0BD

**PARIS OFFICE**  
28 Rue Charles  
Baudelaire  
75012 Paris  
France

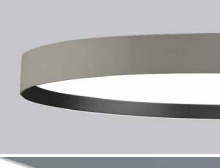
**SWISS OFFICE**  
St. Urbangasse 53  
Postfach 1738  
CH-4502 Solothurn  
Switzerland

**LAXA DECO+ DIRECT-INDIRECT COMPONENTS**

	<b>WHITE FINISH</b> Powder coated finish with matching reflector ring.		<b>SILVER FINISH</b> Powder coated finish with matching reflector ring.		<b>GRAPHITE FINISH</b> Powder coated finish with matching reflector ring.
	<b>BLACK FINISH</b> Powder coated finish with matching reflector ring.		<b>CHAMPAGNE FINISH</b> Powder coated finish with matching reflector ring.		<b>COPPER FINISH</b> Powder coated finish with matching reflector ring.
	<b>WHITE+GOLD</b> Powder coated finish with contrasting reflector ring colour.		<b>WHITE+COPPER</b> Powder coated finish with contrasting reflector ring colour.		<b>WHITE+BLACK</b> Powder coated finish with contrasting reflector ring colour.
	<b>CHAMPAGNE+BLACK</b> Powder coated finish with contrasting reflector ring colour.		<b>BLACK+GOLD</b> Powder coated finish with contrasting reflector ring colour.		<b>BLACK+WHITE</b> Powder coated finish with contrasting reflector ring colour.
	<b>OPAL DIFFUSER</b> Opal polycarbonate diffuser.		<b>MPO DIFFUSER</b> Micro Pyramidal Optic diffuser.		<b>CASAMBI CONTROL</b> Casambi bluetooth control modules.
	<b>CENTRAL SUSPENSION</b> Stainless steel cable, Max height 1500mm.		<b>ROD SUSPENSION</b> Central rod / tube suspension..		



**CASAMBI**

**60 YEARS  
IN LIGHT**

**FOR MORE INFORMATION  
OR TO TALK ABOUT A PROJECT:**

CALL: +44 (0) 1235 55 37 69  
EMAIL: sales@optelma.co.uk

ISSUE DATE: 04/01/21

**HEAD OFFICE**  
The Science Park  
Abingdon  
Oxfordshire  
OX14 3YT

**SHOWROOM**  
23 Bowling Green Lane  
Clerkenwell  
London  
EC1R 0BD

**PARIS OFFICE**  
28 Rue Charles  
Baudelaire  
75012 Paris  
France

**SWISS OFFICE**  
St. Urbangasse 53  
Postfach 1738  
CH-4502 Solothurn  
Switzerland

## LAXA DECO+ DIRECT-INDIRECT SPECIFICATION CODE

AAAA - BB/C/D/E - F/GGG - F/GGG - HHHH/I										
AAAA PRODUCT ID	BB MOUNTING	C FINISH	D DRIVER	E DIFFUSER	F DIRECT LED	GGG CRI / COLOUR	F INDIRECT LED	GGG CRI / COLOUR	HHHH DIAMETER / SIZE (mm)	I EMERGENCY
LAXD	SC SR	B W S G H C X*	F D 1 T C	O M	M H	827 830 840 927 930 940	M H	827 830 840 927 930 940	0300 0400 0500 0600 0800	E

- \* **X** Custom Options - specify details alongside code
- PRODUCT ID **LAXD** LAXA DECO Ceiling Light
- MOUNTING **SC** Suspended Central, **SR** Suspended Rod
- FINISH **B** Black, **W** White, **S** Silver, **G** Graphite, **H** Champagne Silver, **C** Satin Copper
- DRIVER **F** Fixed Output, **D** DALI, **1** 1-10V, **T** Touch Dim, **C** Casambi control
- DIFFUSER **O** Opal, **M** MPO
- DIRECT LED **M** Medium power LED, **H** High power LED
- DIRECT LED CRI / COLOUR **827** CRI 80+ Colour 2700K, **830** CRI 80+ Colour 3000K, **840** CRI 80+ Colour 4000K  
**927** CRI 90+ Colour 2700K, **930** CRI 90+ Colour 3000K, **940** CRI 90+ Colour 4000K
- DIRECT LED CRI / COLOUR **M** Medium power LED, **H** High power LED  
**827** CRI 80+ Colour 2700K, **830** CRI 80+ Colour 3000K, **840** CRI 80+ Colour 4000K  
**927** CRI 90+ Colour 2700K, **930** CRI 90+ Colour 3000K, **940** CRI 90+ Colour 4000K
- DIAMETER / SIZE Diameter/Size in millimetres
- EMERGENCY **E** Standard Integrated Emergency - specify details alongside code
- + **MSENS** Multisensor - specify alongside code  
 For contrasting reflector ring finishes specify details alongside code:  
 +WHITE / +BLACK / +GOLD / +SILVER

### STANDARD

Standard fixed option products for quick and easy specification. Point source LED and Linear LED solutions, organised into Track & Spots, Downlights, Recessed, Surface, Suspended and Wall mounted solutions.

### MADE-TO-MEASURE

Versatile systems and luminaires with custom specifications for project-specific lighting. Available in custom sizes and lengths, with many options including curves, corners, finishes, integrated accessories and more.

### BESPOKE

Bespoke luminaires demonstrating completely custom project solutions, designed with the clients from concept to delivery. Learn about the design process and inspire your next bespoke lighting project.



**CASAMBI**

**60 YEARS  
IN LIGHT**

#### FOR MORE INFORMATION OR TO TALK ABOUT A PROJECT:

CALL: +44 (0) 1235 55 37 69  
 EMAIL: sales@optelma.co.uk

ISSUE DATE: 04/01/21

**HEAD OFFICE**  
 The Science Park  
 Abingdon  
 Oxfordshire  
 OX14 3YT

**SHOWROOM**  
 23 Bowling Green Lane  
 Clerkenwell  
 London  
 EC1R 0BD

**PARIS OFFICE**  
 28 Rue Charles  
 Baudelaire  
 75012 Paris  
 France

**SWISS OFFICE**  
 St. Urbangasse 53  
 Postfach 1738  
 CH-4502 Solothurn  
 Switzerland