

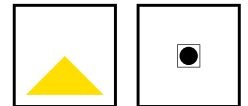

LOTUS WALLWASH

ASYMMETRIC FLUTED BEZEL RECESSED DOWNLIGHT



KEY FEATURES

- Recessed Round Downlight. Asymmetric with fluted bezel
- Asymmetric directional solution
- Bridgelux Thrive full spectrum LED source
- 13W LED Engine run at varying mA to suit project requirements
- CRI 98 as standard
- 15°, 24°, 38°, 55° beam angles
- 2700K, 3000K and 4000K colour temperatures
- Tunable white variation available
- Fixed Output, 1-10V, DALI Dim or Casambi control



CASAMBI

**60 YEARS
IN LIGHT**

CALL: +44 (0) 1235 55 37 69

EMAIL: sales@optelma.co.uk

ISSUE DATE: 23/11/20

HEAD OFFICE

The Science Park
Abingdon
Oxfordshire OX14 3YT
United Kingdom

SHOWROOM

23 Bowling Green Lane
Clerkenwell
London EC1R 0BD
United Kingdom

FRANCE

28 Rue Charles
Baudelaire
75012 Paris
France

SWITZERLAND

St. Urbangasse 53
Postfach 1738
CH-4502 Solothurn
Switzerland

LOTUS WALLWASH DOWNLIGHT SPECIFICATIONS

PRODUCT OPTIONS	
Dimensions (mm):	See table below
Weight (kg):	< 1.0 kg
Lifetime:	50,000 hrs
Mounting type:	Recessed with Trim
Finish:	Trim: Matt White, Matt Black (Custom RAL on request) Reflector: Black, White (Custom RAL on request)
Emergency:	N/A
Operating voltage:	230V
IP Rating:	IP20 (IP44 on request)
Direct Light source:	BridgeLux Thrive full spectrum LED
Driver:	Fixed Output, 1-10V dimming, DALI dimming, Casambi control
Colour temperature:	2700K, 3000K or 4000K, Tunable White
Beam Angle:	15°, 24°, 38°, 55°
Diffuser:	N/A
CRI:	98
Optional Extras:	Emergency conversions on request

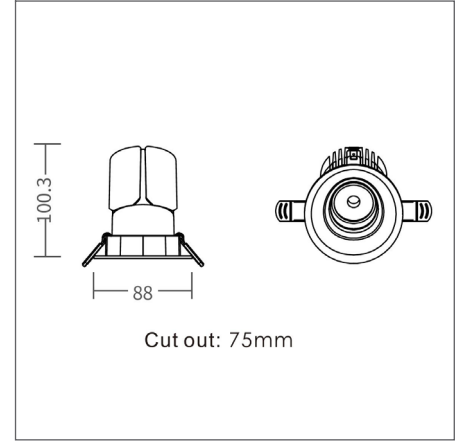

FIXED DIMENSIONS (MM)

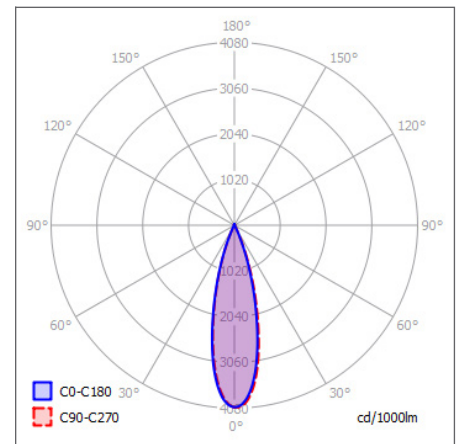

POLAR CURVE 24 DEGREE

CHOOSE FROM OUR RANGE OF SIZES AND OUTPUTS

Option	Dimensions	Cut-out	Connected load	Power	Lumens @ 24°, 4000K
Tunable White	Ø88 x 101	Ø75 mm	-	10 W	-
Fixed	Ø88 x 101	Ø75 mm	9.5 W	8 W	620 lm
Fixed	Ø88 x 101	Ø75 mm	15 W	12.7 W	986 lm

*our drivers offer full control over mA supply. Please enquire if a different output is required for your specific project.



60 YEARS
IN LIGHT

CALL: +44 (0) 1235 55 37 69
EMAIL: sales@optelma.co.uk

ISSUE DATE: 23/11/20

HEAD OFFICE

The Science Park
Abingdon
Oxfordshire OX14 3YT
United Kingdom

SHOWROOM

23 Bowling Green Lane
Clerkenwell
London EC1R 0BD
United Kingdom

FRANCE

28 Rue Charles
Baudelaire
75012 Paris
France

SWITZERLAND

St. Urbangasse 53
Postfach 1738
CH-4502 Solothurn
Switzerland

CASAMBI

COMPONENTS

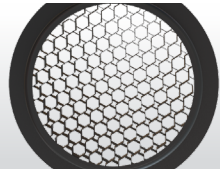

ANTI-GLARE HONEYCOMB
Honeycomb cover to assist in glare control.



13W LED ENGINE
with Bridgelux Thrive LED chips, CRI 98.



GLOBAL OPTIC
15°, 24°, 38° and 55° beam angles.

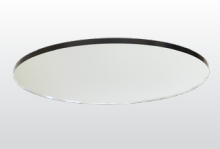

SOFTENING LENS
MPO style softening lens to assist with glare control.

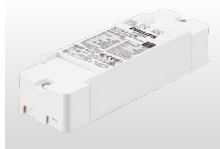

PREMIUM DRIVERS
Fixed Output, L&TE and DALI drivers.



CASAMBI CONTROL
Casambi bluetooth control modules.

LED SOURCE DATA OVERVIEW

Typical CRI values at $T_c = 85^\circ$

Nominal CCT*	R _r	R _g	R ₁	R ₂	R ₃	R ₄	R ₅	R ₆	R ₇	R ₈	R ₉	R ₁₀	R ₁₁	R ₁₂	R ₁₃	R ₁₄	R ₁₅
2700K	95	103	97	99	94	94	97	98	97	98	99	97	91	98	98	95	98
3000K	95	104	98	99	93	94	97	98	96	96	97	96	92	95	98	95	97
3500K	95	98	98	98	97	98	98	98	98	97	93	97	97	95	98	97	98
4000K	97	100	99	99	97	99	99	99	99	98	94	97	99	96	99	98	98
5000K	97	100	98	99	98	98	98	98	99	98	95	98	98	98	98	98	97
5700K	94	98	98	98	97	95	98	97	96	95	92	97	96	96	98	98	97
6500K	95	98	98	98	97	96	98	98	96	96	93	97	96	97	98	98	97

TM-30 Graphs - Data shown @ 4000K

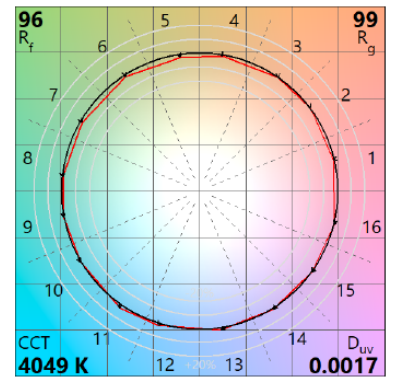
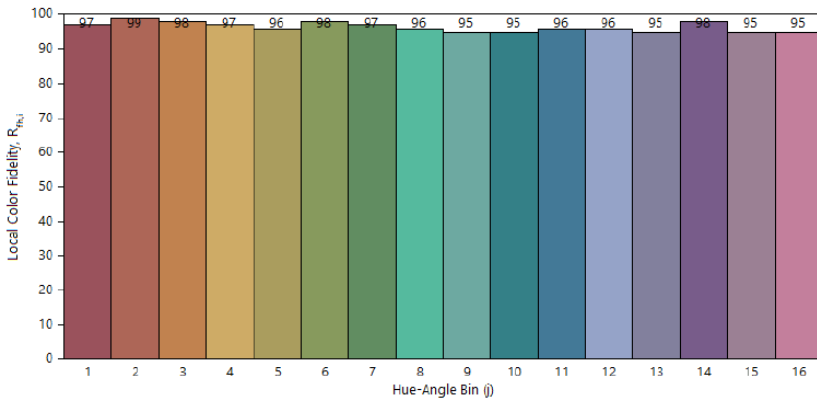

*for full technical data on LED sources please contact Optelma Lighting.



**60 YEARS
IN LIGHT**

CALL: +44 (0) 1235 55 37 69
EMAIL: sales@optelma.co.uk
ISSUE DATE: 23/11/20

HEAD OFFICE
The Science Park
Abingdon
Oxfordshire OX14 3YT
United Kingdom

SHOWROOM
23 Bowling Green Lane
Clerkenwell
London EC1R 0BD
United Kingdom

FRANCE
28 Rue Charles
Baudelaire
75012 Paris
France

SWITZERLAND
St. Urbangasse 53
Postfach 1738
CH-4502 Solothurn
Switzerland